



NEW VEHICLE CONTENT, PRICING & ORDER GUIDE



2023MY Range Rover

DOCUMENT REVISION HISTORY

Date	Detailed Changes
12/22/21	Preliminary Order Guide for 23 MY
1/27/2022	Global Reveal

TABLE OF CONTENTS

- 1. **WHAT'S NEW**.....4
 - RANGE ROVER SV 5
 - NEW RANGE ROVER SV..... 8
 - SV INTREPID..... 9
 - SV SERENITY 13
 - RANGE ROVER PHEV..... 18
- 2. **LAUNCH TIMING**.....20
- 3. **TECHNICAL SPECIFICATIONS** 21
- 4. **DIMENSIONS**.....22
- 5. **STANDARD EQUIPMENT** 23
- 6. **PRICING, OPTIONS, OPTION PACKS & ACCESSORIES**.....26
- 7. **EXTERIOR COLORS**.....29
- 8. **WHEELS AND TIRES**..... 31
- 9. **TRIM FINISHERS AND VENEERS** 33
- 10. **PRICING APPENDIX** 34

1. WHAT'S NEW

Updated Content Change From Preliminary Release (in Red)

Pricing and Content Change on P400 SE

- Pricing has been reduced by \$3,000
- Dynamic Response Pro and Electronic Active Differential removed as standard equipment and are now available optionally in the Advanced Off-road Capability Pack

New Optional Content

- Pixel LED (Now Standard on ATB and above)
- Power Assisted Door (Mid Model Year - TBC)
- Remote Park Assist (Removed)
- Wood and Leather Open Pore Wheel
- Advanced Off-Road Capability Pack

Consolidated Options Available Now Only in Packs

- ClearSight interior rear view mirror
- Domestic plug socket(s)
- Head-up Display
- SV Bespoke Full Extended Leather Upgrade
- Configurable Programs

Deleted Content

- 20-way heated and ventilated electric front seats with power recline heated rear seats
- 20-way heated and ventilated electric front seats with power recline heated rear seats and heated third row seats
- Convenience Pack
- Activity Key
- "L" Badge on pillar designating LWB vehicles
- Ostuni White not available at launch. Availability TBC.

RANGE ROVER SV

The all-new Range Rover SV will be the ultimate expression of Range Rover for drivers and passengers, building upon the success of outgoing SVAutobiography, with improved quality, comfort, and enhanced technology, to provide segment leadership in luxury and expansive breadth of capability.



SV SIGNATURE SUITE

The interior package will transform the customer's SV creating a distinct and luxurious 4-seat interior environment finished to the highest standard with quality materials. Included with this package are:

- **Electrically Deployable Club Table** A central deploying table with sculpted support arm and exclusive configurable ambient feature lighting – operated from the Rear Seat Touchscreen Controller device



Available as two options based on table surface preference:

- SV Signature Suite with Veneer Club Table Surface – 017HP
- SV Signature Suite with Leather Club Table Surface – 017HN

- First class fixed rear full-length console trimmed in Windsor leather or PU (depending on colourway choice) with veneer topper and integrated ambient lighting



NEW RANGE ROVER SV



SV Exterior Accents (standard) – 032MY will give customers an exclusive visual exterior enhancement. The key features are:

- Exclusive Range Rover script with Graphite Atlas inserts and Silver satin surround
- Exclusive metal plated upper grille with Atlas Silver finish and surround
- Exclusive metal plated front bumper with upper accents and lower accent in Atlas Silver finish
- Exclusive metal plated door gills with an Atlas Silver finish surround and Graphite Atlas inserts with etched “SV” roundel
- Exclusive metal plated rear fender ingots in Atlas Silver finish
- Exclusive metal Lower tailgate finisher in Atlas Silver finish

SV SWB & LWB – standard choice

Choice of two Semi-Aniline colourways with SV differentiated seat foams, seat style and exclusive Mosaic embroidery:

- SV Ebony Semi Aniline leather seats with Ebony interior – 303UL
- SV Perlino Semi Aniline leather seats with Perlino interior – 303UR

And now, for the first time, two exterior themes will be available on both SWB and LWB vehicle variants – offering a full breadth of choice to our most discerning customers.

SV INTREPID



SV Intrepid Exterior Accents – 032ME will give customers a distinct and dynamic visual exterior enhancement to the standard specification.

The key features are:

- Exclusive Range Rover script with two-tone Graphite Atlas inserts and Anthracite gloss surround
- Exclusive metal plated two-piece upper grille with Anthracite finish and Graphite Atlas surround
- Exclusive metal plated front bumper with upper accents in Anthracite finish and lower accent in Graphite Atlas
- Exclusive metal plated door gills with Anthracite finish inserts and Graphite Atlas surround
- Exclusive rear fender ingots with Graphite Atlas finish
- Exclusive metal lower tailgate finisher in Anthracite finish

SV SWB & LWB – SV Intrepid Interior Colourways - Choice of three SV Intrepid interior colourways with SV differentiated seat foams, black ceramic controls, seat style and rectangle perforation (See Veneer section for



accompanying trim).
SV Intrepid premium Ultrafabric non-leather interior Cinder Grey front and Light Cloud rear– 303UN shown above.



- SV Intrepid Rosewood Near Aniline leather front and Ebony Semi Aniline leather rear seats with Ebony Interior – 303UP



- SV Intrepid Ebony Semi Aniline leather seats with Ebony interior – 303UQ

SV SERENITY



SV Serenity Exterior Accents – 032MZ will give customers a distinct and luxurious visual exterior enhancement to the standard specification. This pack will also be available on both SWB and LWB vehicle variants (no cost option on SV LWB). The key features are:

- Exclusive Range Rover script with two-tone Corinthian Bronze inserts and Silver satin surround
- Exclusive metal plated two-piece upper grille with Atlas Silver finish and Corinthian Bronze surround
- Exclusive metal plated front bumper with upper accents in Atlas Silver finish and lower accent in Corinthian Bronze
- Exclusive metal plated door gills with an Atlas Silver finish inserts and Corinthian Bronze surround
- Exclusive rear fender ingots in Corinthian Bronze finish
Lower tailgate finisher in Corinthian Bronze finish

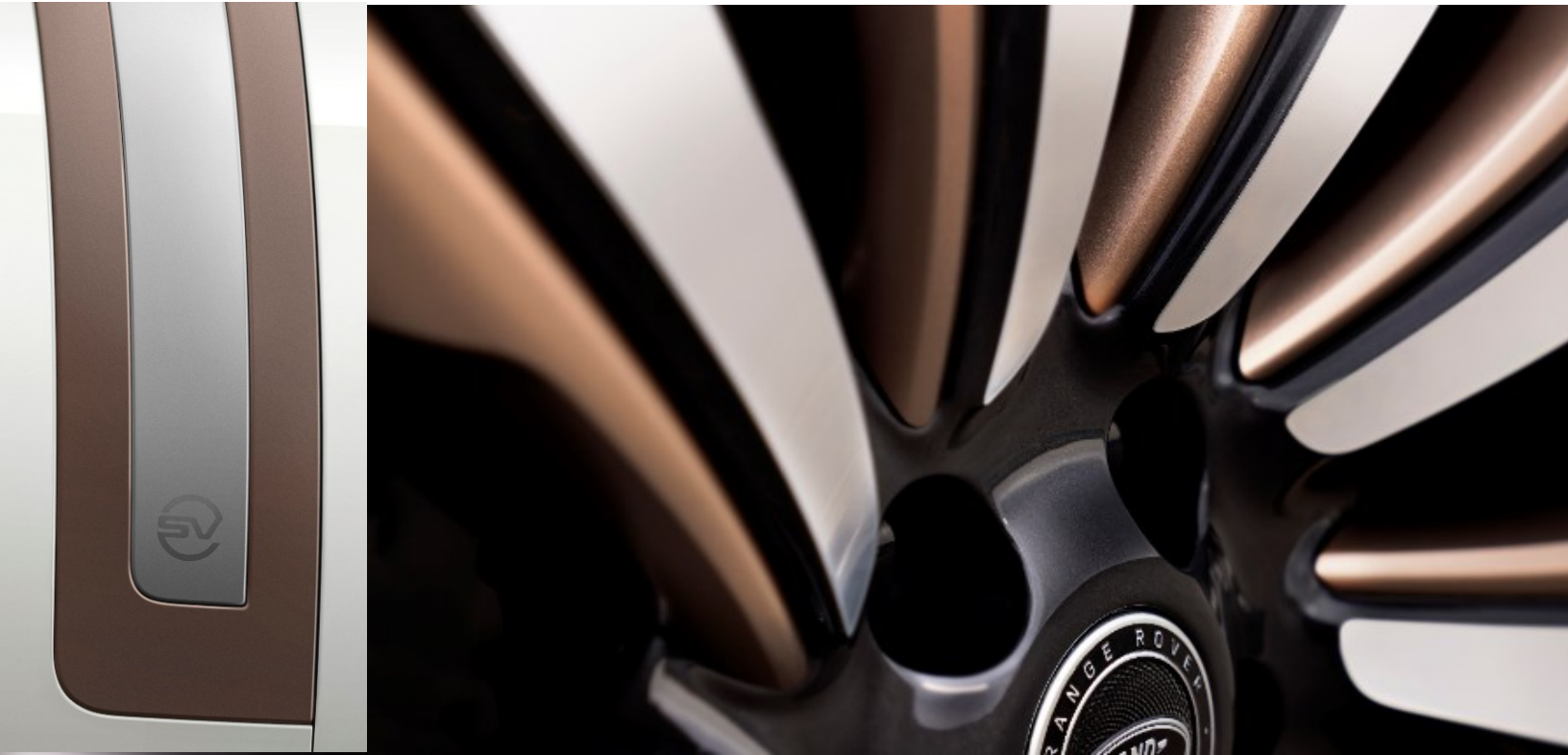

SV SWB & LWB – SV Serenity Interior Colourways – Choice of three SV Serenity interior colourways with differentiated seat foams, white ceramic controls, leather upgrade to Near Aniline on non-Perlino surfaces, seat style, and Mosaic embroidery with visual emphasis on the rear seats. Carraway 303UJ pictured below :





- SV Serenity Sequoia Green Near Aniline leather front and Perlino Semi-Aniline leather rear seats with Sequoia Green interior – 303UM (Available from Mid 2022 on)



- SV Serenity Liberty Blue Near Aniline leather front and Perlino Semi-Aniline leather rear seats with Liberty Blue interior – 303UK (Available from Mid 2022 on)

VENEERS

L460 SV demonstrates a true uplift in veneer and trim finisher offerings with all new and exclusive choices for customers including mosaic patterned wood and white ceramic.

- 088UP - Natural dark linear wenge veneer with mosaic metal inlay

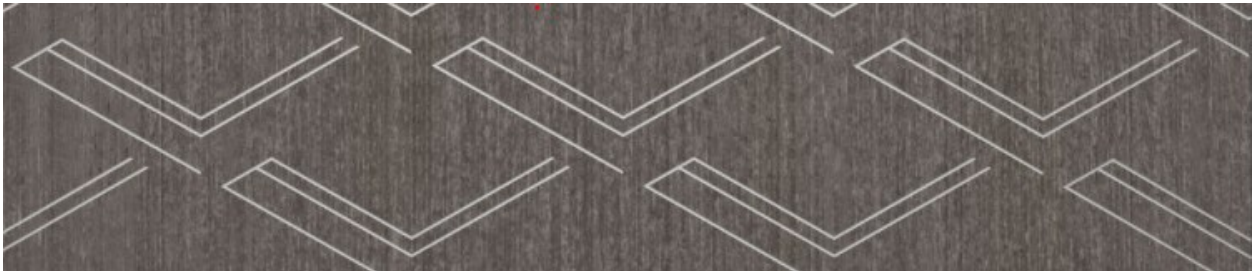

- 088UQ - Natural light linear wenge veneer with mosaic marquetry

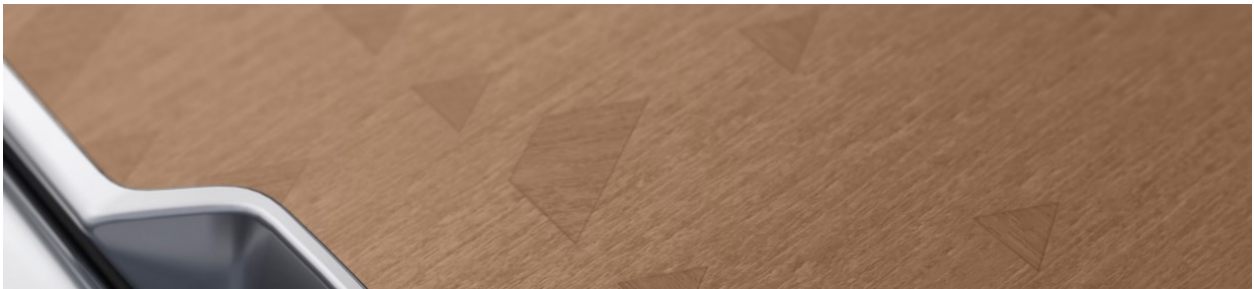

- 088UG – Satin white ceramic with embossed mosaic - a first material introduction to the brand complimented by ceramic controls.



RANGE ROVER PHEV

Range Rover's New Plug-in Hybrid Electric Vehicle (PHEV), is new and improved at 23 Model Year with several key advantages over the outgoing model and its competition:

More Power

The new PHEV engine combines the 3.0l 6-cylinder Ingenium petrol combustion engine (ICE) producing 395HP with a 105kW electric motor to deliver a combined 434HP – an overall improvement of 39 HP. See technical specifications chart for additional detail on engine performance.

Faster Charge Time

Range Rover PHEV is one of the very few PHEVs available today with 50kW DC charging capability, and is therefore one of the fastest PHEVs to charge. It can charge up to 6 times faster than competitors, when comparing its 50kW DC rapid charging capability to competitors limited to 7.2kW AC. It has the capability to rapid charge 0-80% in under 1 hour (using a DC 50kW charger).



Better Battery Placement

MLA-Flex Platform for Range Rover has been engineered with cabin occupant space in mind on EV platforms. As such, the High Voltage Battery installed in the PHEV is packaged within the wheelbase of the vehicle, directly underneath the cabin. This is an improvement over prior generation as it eliminates the need to compromise the load space, also allowing the fitment of a full-size spare wheel.

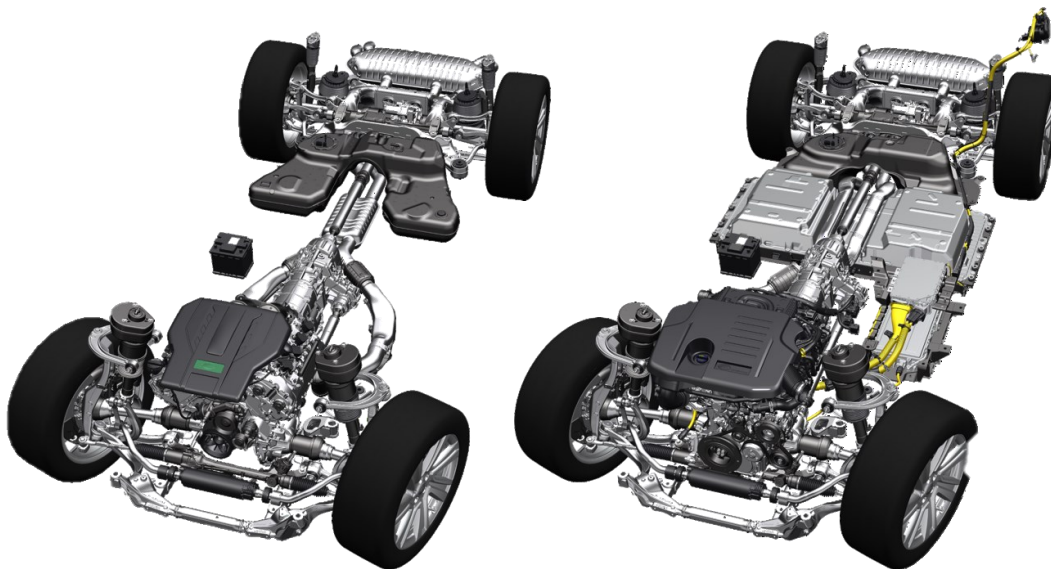

ICE Engine
Hybrid

Plug-in

Extended EV Only Range

The new PHEV boasts a preliminary pure EV Range estimated at 48 miles; a significant improvement in zero emissions driving capability and strong selling proposition for the eco-minded buyer considering an electrified powertrain.

2. LAUNCH TIMING

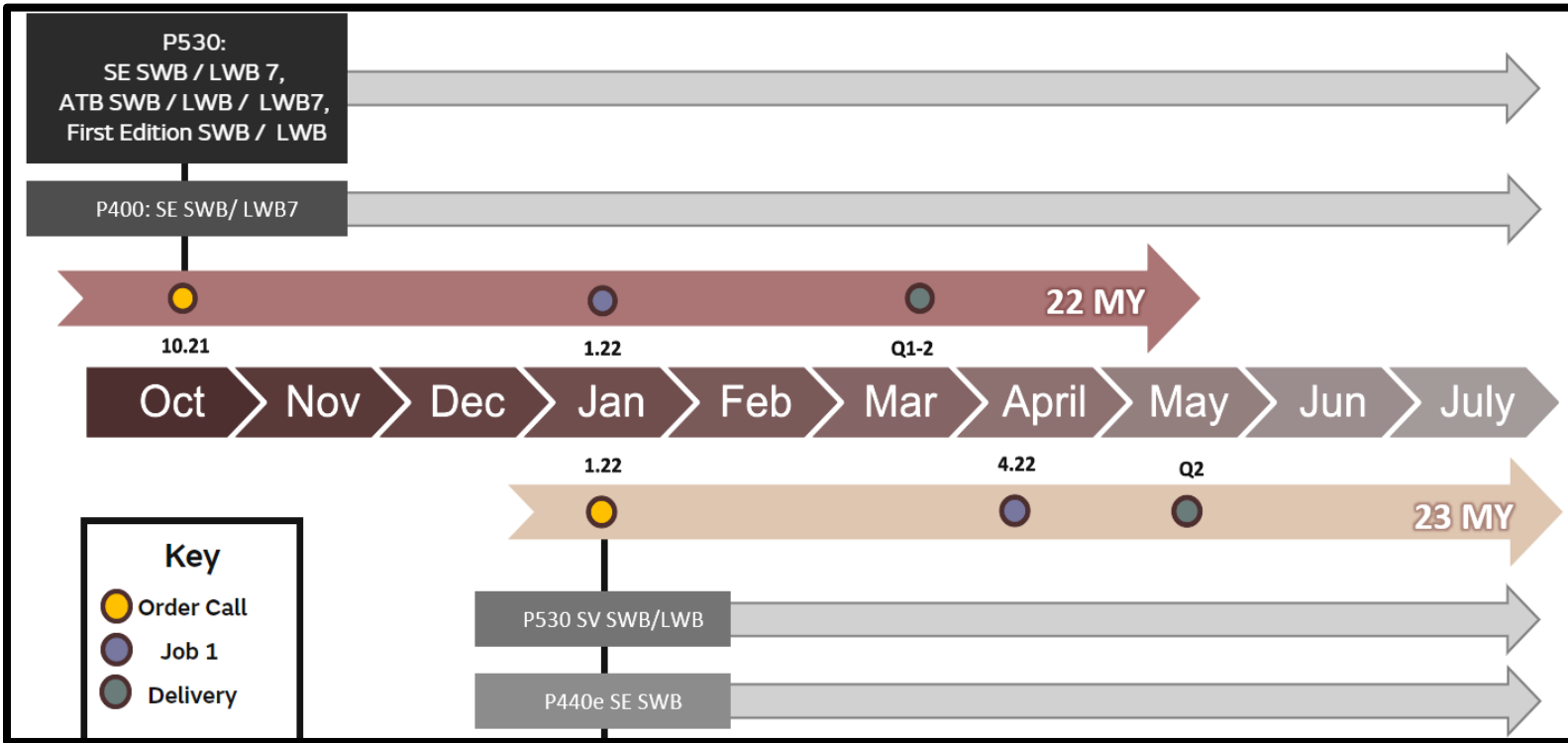

3. TECHNICAL SPECIFICATIONS

	P400	P440	P530
Engine	3.0L i6 MHEV Gas	3.0L i6 Plug-in Hybrid Gas	4.4L V8 Twin Turbo Gas
Engine Displacement (cc)	2996	2996	4395
Engine Fuel Injection System	Direct Injection	Direct Injection	Direct Injection
Bore/Stroke (inch)	3.27 / 3.63	3.27 / 3.63	3.64 / 3.66
Compression Ratio : 1	10.5	10.5	10.5
Power: HP @ rpm	395 @ 5,500 - 6500	434hp @ 5,500 - 6,500	523 @ 5,500 - 6,000
Torque: lb-ft @ rpm	406 @ 2,000 - 5,000	369 @ 2,000 - 5,000	553 @ 1,800 - 4,600
0-60 mph (seconds)	5.5 (SWB), 5.8 (LWB7)	5.7	4.4 (SWB), 4.5 (LWB), 4.6 (LWB7)
Top speed	150 mph	155 mph	155 mph
Transmission	Eight-speed ZF 8HP76X automatic	Eight-speed ZF 8P75PH automatic	Eight-speed ZF 8HP76X automatic
Drive Type	All Wheel Drive (AWD)	All Wheel Drive (AWD)	All Wheel Drive (AWD)
EPA Fuel Economy city/hwy/cmbd mpg	TBC	TBC	TBC
Fuel Tank Capacity (gal.)	23.8	18.9	23.8
Brakes	Four-wheel disc / ABS	Four-wheel disc / ABS	Four-wheel disc / ABS
Brake Size Front / Rear (inch)	14.9"/13.9"	14.9"/13.9"	15.7"/14.5"
Tow Capacity	7716	5511	7716
Final Drive Ratio : 1	3.6	3.7	3.3

4. DIMENSIONS

	SWB	LWB
Wheelbase (in.)	118 (+3" vs. Current Gen)	126 (+3" vs. Current Gen)
Overall Length (in)	199 (+2" vs. Current Gen)	207
Overall Width (in)	87	87
Overall Width w/ Mirrors Folded (in)	81	81
Overall Height (in)	74	74
Curb Weight (lbs)	6cyl: 5,240 8 cyl: 5,530	6cyl: 5,385 - 5,600 (7 seat) 8cyl: 5,620 - 5,840 (7 seat)
Gross Vehicle Weight (lbs)	7,385	7,385 - 7,560
Turning Circle - Curb to Curb (ft.)	36	37"10"
Tire Size (Standard Fit)	275/50 R21 A/S (SE) 285/45 R22 A/S (ATB, SV) 285/40 R23 A/S (FE)	
Trunk Volume (ft ³) behind First Row	83.5	92.9
Trunk Volume (ft ³) behind Second Row	40.7 (+6 cu ft vs. Current Gen)	5 seat 40.9 / 7 seat 43.1 (+6 cu ft vs. Current Gen)
Trunk Volume (ft ³) behind Third Row	NA	8.7
First Row Legroom	40	
Second Row Legroom	40.4 (+1.7" vs. Current Gen)	48/40.4 (+1.7" vs. Current Gen)
Third Row Legroom	N/A	34
Wading Depth	35.4 in	35.4 in

5. STANDARD EQUIPMENT

	Body Style Specific Standard Equipment		
	SWB	LWB	LWB 7
SE			
Laminated front and rear side glass	•		
Laminated front and toughened rear side glass		•	•
Three-zone Climate Control	•		
Four-zone Climate Control		•	•
Electric rear side window sunblinds		•	•
20-way heated electric front seats with power recline heated rear seats	•	•	
20-way heated electric front seats with power recline heated rear seats and heated third row seats			•
ATB (In addition to SE)			
24-way heated and cooled, hot stone massage electric front seats with Executive Class Comfort rear seats	•	•	
24-way heated and cooled, massage electric front seats with power recline heated and ventilated rear seats and heated third row seats			•
Auto-Fold Loadspace Cover	•	•	
First Edition (In addition to ATB)			
24-way heated and cooled, hot stone massage electric front seats with Executive Class Comfort Plus rear seats	•	•	
SV Edition (In addition to ATB)			
Mohair mats with leather binding		•	
Intrusion Sensor		•	
SV Serenity exterior accents (Available as NCO)		•	
Corinthian Bronze contrast roof (Available as NCO)		•	

Standard Equipment Walk						
	SE	SE	SE	ATB	First Edition	SV
Powertrain/Dynamics						
395hp 3.0l i6 Turbocharged Gas Engine	•					
434hp 3.0L i6 Turbocharged Gas PHEV		•				
523hp 4.4L V8 TurboCharged Gas Engine			•	•	•	•
Configurable Programs			•	•	•	•
Electronic Active Differential w/ Torque Vectoring by Braking			•	•	•	•
Dynamic Response Pro			•	•	•	•
Home charging cable		•				
Exterior						
Nickel Atlas Exterior Pack	•	•	•			
Autobiography Exterior Pack				•	•	
Autobiography badge				•		
SV exterior accents						•
SV exterior badge						•
Laminated front and rear side glass				•	•	•
Laminated front and toughened rear side glass	•	•	•			
Unpainted brake calipers	•	•	•			
Black brake calipers				•	•	•
Pixel LED headlight with signature DRL				•	•	•
Technology						
Meridian™ Sound System	•	•	•			
Meridian™ Signature Sound System				•	•	•
11.4" Rear Seat Entertainment				•	•	
13.1" Rear Seat Entertainment						•
Domestic plug socket				•	•	•
Head-up Display				•	•	•
Park Assist				•	•	•
Power Assisted Doors (Available Mid-23 Model Year)						•

	Standard Equipment Walk					
	SE	SE	SE	ATB	First Edition	SV
Powertrain/Dynamics						
395hp 3.0L i6 Turbocharged Gas Engine	•					
434hp 3.0L i6 Turbocharged Gas PHEV		•				
523hp 4.4L V8 TurboCharged Gas Engine			•	•	•	•
Interior						
Illuminated seat belt buckles				•	•	•
Carpet mats	•	•	•			
SV Bespoke Carpet mats				•	•	•
Natural Brown Walnut veneer	•	•	•			
SV Bespoke Natural Brown Walnut veneer with Inlay				•		
Natural Ecru Walnut veneer with inlay and First Edition script					•	
Natural Cream Ash Burr veneer						•
Non-heated steering wheel	•	•	•			
Heated steering wheel				•	•	•
Aluminium treadplates with Range Rover script	•	•	•			
Illuminated metal treadplates with Autobiography script				•		
Illuminated metal treadplates with First Edition script					•	
Illuminated aluminium treadplates with illuminated SV script						•
Extended Leather Upgrade	•	•	•			
Ebony perforated Windsor leather seats with Ebony interior	•	•	•			
Ebony perforated Semi-Aniline leather seats with Ebony interior				•		
Perlino perforated Semi-Aniline leather seats with Perlino interior					•	
SV Semi-Aniline leather Seats with Ebony Interior						•
SV Bespoke Full Extended Leather Upgrade				•	•	•
Duo Tone Ebony/Perlino headlining	•	•	•			
SV Bespoke Duo Tone Ebony/Perlino Leather Headlining				•	•	
SV Bespoke leather headlining						•
Gloss White ceramic controls						•
Auto-dimming interior rear view mirror	•	•	•			
ClearSight interior rear view mirror				•	•	•
Electric rear side window sunblinds				•	•	•
Centre console with armrest	•	•	•			
Front centre console refrigerator compartment				•	•	•
Three-zone Climate Control	•	•	•			
Four-zone Climate Control				•	•	•
Cabin Air Purification Pro				•	•	•
Loadspace cover	•	•	•			
Auto-folding loadspace cover				•	•	•
Versatile loadspace floor				•		•
Tailgate Event Suite with Leather Cushions					•	

6. PRICING, OPTIONS, OPTION PACKS & ACCESSORIES

	Option Code	SWB			LWB		LWB 7 Seat		SV	
		SE	ATB	First Edition	ATB	First Edition	SE	ATB	SWB	LWB
395hp 3.0l i6 Turbocharged and Supercharged Gas Engine	N/A	\$101,000					\$107,000			
434hp 3.0l i6 Plug-in Hybrid Engine	N/A	\$104,900								
523hp 4.4L V8 Twin TurboCharged Gas Engine	N/A		\$118,700	\$152,450	\$158,650	\$156,450	\$163,950	\$124,700	\$154,450	\$186,850 \$211,200

	Option Code	SWB			LWB		LWB 7 Seat		SV	
		SE	ATB	First Edition	ATB	First Edition	SE	ATB	SWB	LWB
Driver Assistance Technologies										
Advanced Tow Assist	062CE	\$450	\$450	\$450	\$450	\$450	\$450	\$450	\$450	\$450
Park Assist	086MC	\$200					\$200			
Technology Pack										
Clearsight Interior rear view mirror	074KY	\$2,000								
Domestic Plug Socket										
Head-up Display										
Versatility and Capability Features										
Configurable Programs (Pack only on SE SWB i6 & PHEV)	184AD	\$550					\$550			
Advanced Off-Road Capability Pack (N/A on 8 Cylinder SE)										
Electronic Active Differential with Torque Vectoring by Braking	074PM	\$5,250								
Electronic Air Suspension with Dynamic Response										
Configurable Programs										
Climate Control Options										
Hot Climate Pack										
Electric rear side window sunblinds	017ED	\$2,200								
Front center console refrigerator compartment										
Four-zone Climate Control										
Cabin Air Purification Pro										
Technology: Multimedia										
Cabin Air Purification Pro	022GJ						\$500			
Meridian™ 3D Surround Sound System	025MN	\$1,200					\$1,200			
11.4" Rear Seat Entertainment	129AW	\$3,150					\$3,150			
No Rear Seat Entertainment	129XX		NCO	NCO	NCO	NCO		NCO	NCO	NCO
Power Assisted Doors (Available Mid Model Year)	173AD	\$1,750	\$1,750	\$1,750	\$1,750	\$1,750	\$1,750	\$1,750		
Soft Close Doors	173AB									NCO
Exterior Options										
Shadow Exterior Pack										
Must call Black contrast roof on First Edition and 23" Crescendo wheel	032XX	\$1,000	\$1,000	\$1,000	\$1,000	\$1,000	\$1,000	\$1,000	\$1,000	
Graphite Trim: Grill tips, Door Gill Surround, Tailgate Finisher, Bumper Grill Blades, Tow Eye Cover, Rear Side Ingot, Hood/Tailgate Lettering.										
Nickel Atlas Exterior Pack										
Nickel Atlas Trim: Grill tips, Door Gill Surround, Tailgate Finisher, Bumper Grill Blades, Tow Eye Cover, Rear Side Ingot, Hood/Tailgate Lettering.	032MT		NCO	NA	NCO	NA		NCO		
Black contrast roof										
Not available with Black paints	080AN	\$1,000	\$1,000	\$1,000	\$1,000	\$1,000	\$1,000	\$1,000	\$1,000	\$1,000
Must call Shadow Ext. Pack and 23" Wheel on First Edition.										
Black brake calipers	020BK	\$550					\$550			
Heated windscreen	040AK	\$350	\$350	350	\$350	\$350	\$350	\$350	\$350	\$350
Tow hitch receiver	028LB	\$750	\$750	750	\$750	\$750	\$750	\$750	\$750	\$750
Self-sealing tyres (N/A on PHEV)	030JC	\$200	\$200	200	\$200	\$200	\$200	\$200	\$200	\$200
Pixel LED headlights with signature DRL	064QW	\$550					\$550			
Red brake calipers	020BE								\$510	\$510
Corinthian Bronze contrast roof	080IK								\$1,500	NCO
SV Serenity exterior accents										
Not available with 303UN, 303UP, 303UQ	032MZ									
Corinthian Bronze technical paint is used for exterior accents, emphasizing its exclusivity. Especially when paired with the optional Corinthian Bronze contrast roof and matching 23" forged Diamond Turned alloy wheels with Corinthian Bronze inserts										
SV Intrepid exterior accents										
Not available with 303UM, 303UJ, 303UK	032PX									
Graphite Atlas-painted finishes, an optional black contrast roof and complementary 23" forged Satin Dark Grey alloy wheels with Narvik Black Gloss inserts complete the look.										

Changes in standard equipment, options or prices can occur. Land Rover reserves the right to change product specifications at any time without incurring any obligations.



	Option Code	SWB			LWB		LWB 7 Seat		SV		
		SE	ATB	First Edition	ATB	First Edition	SE	ATB	SWB	LWB	
Interior Options											
Perfino headlining <i>Only available with Ebony or Perfino Interiors</i>	188MA	\$400	NCO	NA	NCO	NA	\$400	NCO	NA		
Ebony Morzine headlining	188HD	\$400	NCO	NA	NCO	NA	\$400	NCO			
Duo Tone Ebony/Perfino headlining <i>Only available with Ebony or Perfino Interiors. Must call 301RM on First Editions</i>	188HW	S	NCO	NCO	NCO	NCO	S	NCO			
Duo Tone Ebony/Caraway headlining <i>Only available with Caraway Interiors N/A with 115AB</i>	188HV	NCO	NA			NCO	NA				
Duo Tone Ebony/Ecru headlining <i>Only available with Ecru Interiors</i>	188HX	NCO	NA								
Duo Tone Ebony/Deep Garnet headlining <i>Only available with Deep Garnet Interior N/A with 115AB</i>	188HZ	NCO	NA								
SV Bespoke Ebony leather headlining <i>N/A with 301RM Ultrafabrics</i>	188HQ	NA	NCO	NA	NCO	NA	NCO	S			
SV Bespoke Perfino Leather Headlining <i>Only available with Ebony or Perfino Interiors N/A with 301RM Ultrafabrics</i>	188MM	NA	NCO	NA	NCO	NA	NCO	NCO	NCO		
SV Bespoke Duo Tone Ebony/Caraway Leather Headlining <i>Only available with Caraway Interiors N/A with 301RM Ultrafabrics</i>	188MG	NA	NCO	NA	NCO	NA	NCO	NA			
SV Bespoke Duo Tone Ebony/Deep Garnet Leather Headlining <i>Only available with Deep Garnet Interiors N/A with 301RM Ultrafabrics</i>	188ML	NA	NCO	NA	NCO	NA					
Premium Upgrade Interior Pack <i>Laminated front and rear side glass SV Bespoke Carpet mats Illuminated metal treadplates with brand-name script SV Bespoke Full Extended Leather Upgrade</i>	017HE	\$2,000	NA			\$1,850	NA				
Tailgate Event Suite <i>Must call Meridian Surround</i>	079EK	\$1,250	\$500	NCO	NCO	NCO	NA	\$500	\$500		
Tailgate Event Suite with Leather Cushions <i>Not available with full size spare</i>	079EL	\$1,950	\$1,200	S	\$1,200	S	\$1,950	\$1,200	\$1,200	\$1,200	
Front center console refrigerator compartment	045CB	P	S			\$750	S				
Illuminated seat belt buckles (\$100 Cost Option on PHEV) <i>Must call Ultrafabric or Semi-Aniline on 5 seat SE Must call Semi Aniline on 7 seat SE</i>	032QB	NCO	S			NCO	S				
Heated steering wheel	032DV	\$300	S			\$300	S				
Premium non-leather steering wheel <i>Must call heated wheel and Ultrafabric Interior</i>	032LZ	NCO	NCO	NCO	NCO	NCO	NA	NCO	NCO		
SV Bespoke Wood and leather steering wheel (Gloss) <i>Must call heated wheel. N/A with Ultrafabric Interior</i>	032NR	\$550	\$550	\$550	\$550	\$550	\$550	\$550	NA		
SV Bespoke Wood and leather steering wheel (Open Pore) <i>Must call heated wheel. N/A with Ultrafabric Interior</i>	032NT	\$550	\$550	\$550	\$550	\$550	\$550	\$550	\$550	\$550	
Loadspace partition net	026EU	NA	\$100	NA	\$100	NA	P	\$100	\$100	\$100	
Caraway carpet	124BC	NA								NCO	NCO
Mohair mats with leather binding	079DP									\$1,350	S
Pearl Oyster Carpet	124BE									\$1,950	\$1,950
Sequoia Green Carpet	124BF									NCO	NCO
Liberty Blue Carpet	124BG									NCO	NCO
Cinder Grey Carpet	124BH									NCO	NCO
SV Deep Pile carpet mats	079DV									\$1,350	\$1,350
Satin Black ceramic controls	305BD									NCO	NCO
SV Serenity Caraway Near-Aniline leather front and Perfino Semi-Aniline leather rear seats with Caraway interior	303UJ									\$3,300	\$3,300
SV Serenity Liberty Blue Near-Aniline leather front and Perfino Semi-Aniline leather rear seats with Liberty Blue interior	303UK									\$3,300	\$3,300
SV Serenity Sequoia Green Near-Aniline leather front and Perfino Semi-Aniline leather rear seats with Sequoia Green interior	303UM									\$3,300	\$3,300
SV Intrepid Light Cloud front and Cinder Grey rear Ultrafabric seats with Cinder Grey interior	303UN									\$3,300	\$3,300
SV Intrepid Rosewood Near-Aniline leather front and Ebony Semi-Aniline leather rear seats with Ebony interior	303UP									\$3,300	\$3,300
SV Intrepid Ebony Semi-Aniline leather seats with Ebony interior	303UQ									\$3,300	\$3,300
SV Perfino Semi-Aniline leather seats with Perfino interior	303UR									NCO	NCO
Caraway leather headlining	188MR									NCO	NCO
Liberty Blue leather headlining	188MS									NCO	NCO
Sequoia Green leather headlining	188MT									NCO	NCO
Cinder Grey Ultrafabrics headlining	188MV									NCO	NCO
SV Signature Suite with Leather Club Table Surface	017HN									NA	\$19,740
SV Signature Suite with Veneer Club Table Surface	017HP	NA	\$19,740								













Changes in standard equipment, options or prices can occur. Land Rover reserves the right to change product specifications at any time without incurring any obligations.

Option Code	SWB			LWB			LWB 7 Seat		SV		
	SE	ATB	First Edition	ATB	First Edition	SE	ATB	SWB	LWB		
Seating											
20-way heated and ventilated electric front seats with power recline heated and ventilated rear seats	401AJ	\$600	NA								
20-way heated and ventilated electric front seats with power recline heated and ventilated rear seats and heated third row seats	401AK	NA					\$600	NA			
24-way heated and cooled, massage electric front seats with power recline heated and ventilated rear seats <i>SE Must call Semi Aniline Leather</i>	401AM	\$2,000	NCO	NCO	NCO	NCO	NA				
24-way heated and cooled, massage electric front seats with power recline heated and ventilated rear seats and heated third row seats <i>SE Must call Semi Aniline Leather</i>	401AN	NA					\$1,600	S	NA		
24-way heated and cooled, massage electric front seats with Executive Class rear seats <i>SE Must call Semi Aniline Leather or Ultrafabric Interior</i>	401AP	\$4,200	NCO	NCO	NCO	NCO	NA				
24-way heated and cooled, hot stone massage electric front seats with Executive Class Comfort Plus rear seats	401AR	NA	\$3,800	S	NA			S	NA		
24-way heated and cooled, hot stone massage electric front seats with Executive Class Comfort Plus rear seats	401AS	NA			\$5,200	S	NA			S	
Caraway perforated Windsor leather seats with Caraway interior	301MY	NCO	NA				NCO	NA			
Perlino perforated Windsor leather seats with Perlino interior	301MZ	NCO	NA				NCO	NA			
Ecru perforated Windsor leather seats with Ecru interior	301RA	NCO	NA								
Ebony perforated Semi-Aniline leather seats with Ebony interior <i>Must call seat 401AM, 401AN, 401AP, 401AK</i>	301RB	\$1,850	S	NCO	S	NCO	\$1,850	S	NA		
Caraway perforated Semi-Aniline leather seats with Caraway <i>Must call seat 401AM, 401AN, 401AP, 401AK</i>	301RC	\$1,850	NCO	NA	NCO	NA	\$1,850	NCO	NA		
Perlino perforated Semi-Aniline leather seats with Perlino interior <i>Must call seat 401AM, 401AN, 401AP, 401AK</i>	301RD	\$1,850	NCO	S	NCO	S	\$1,850	NCO	NA		
Deep Garnet perforated Semi-Aniline leather seats with Deep Garnet <i>Must call seat 401AM, 401AN, 401AP, 401AK</i>	301RF	\$1,850	NCO	NA	NCO	NA					
SV Bespoke Ebony perforated Near-Aniline leather seats with Ebony	301TG	NA	\$1,150	NA	\$1,150	NA					
Ebony perforated Ultrafabrics™ and Kvadrat™ premium wool blend textile seats with Ebony interior <i>Must call 401AP</i>	301RM	NCO	NCO	NCO	NCO	NCO	NA				
Ebony perforated Windsor leather seats with Perlino interior	301TJ	NCO	NA				NCO	NA			
Ebony perforated Semi-Aniline leather seats with Perlino interior	301TM	\$1,850	NCO	NA	NCO	NA	\$1,850	NCO	NA		
SV Bespoke Ebony perforated Near-Aniline leather seats with Perlino interior	301TS	NA	\$1,150	NA	\$1,150	NA					
Premium Non-Leather Upgrade <i>Must call Ultrafabrics Interior</i>	032KF	NCO	NCO	NCO	NCO	NCO	NA		NCO	NCO	
Accessories											
Emergency Pack	LRX95	\$65	\$65	\$65	\$65	\$65	\$65	\$65	\$65	\$65	
Premium Interior Protection & Storage Pack <i>Rubber Mats, Loadspace Mat, Cargo Carrier</i>	RR001	\$650	\$650	\$650	NA			\$650	NA	NA	
	RR071	NA					\$650	\$650	NA	NA	
Wheel Protection Pack <i>Wheel locks, Valve caps</i>	RR003	\$190	\$190	\$190	\$190	\$190	\$190	\$190	\$190	\$190	
Fixed Side Steps	RR005	\$1,600	\$1,600	\$1,600	NA			\$1,600	NA	NA	
	RR009	\$4,200	\$4,200	\$4,200	NA			\$4,200	NA	NA	
Deployable Side Steps (not PHEV)	RR0L9	NA				\$4,600	\$4,600	NA		NA	\$4,600
	RR079	NA				NA	NA	\$4,600	\$4,600	NA	NA

Changes in standard equipment, options or prices can occur. Land Rover reserves the right to change product specifications at any time without incurring any obligations.

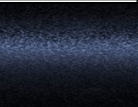

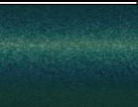
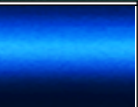





7. EXTERIOR COLORS

Paint Color	Option Code	SE	ATB	First Edition	SV
Solid					
 Fuji White	1AA	NCO		NA	
Metallic					
 Santorini Black	1AG	NCO			
 Eiger Grey	1DF	NCO		NA	NCO
 Hakuba Silver	1DU	NCO		NA	NCO
 Belgravia Green	1DV	NCO		NA	NCO
 Lantau Bronze	1DP	NCO			NA
 Portofino Blue	1DG	NCO		NA	NA
 Borasco Grey	1CN	NA			NCO
 Varesine Blue	1EH				NA
Premium Metallic					
 Carpathian Grey	1AU	\$1,950		NA	\$1,950
 Silicon Silver	1BN	\$1,950		NA	NA
 Batumi Gold	1DM	\$1,950		NCO	NA
 Charente Grey	1DN	\$1,950		NCO	NA







SV Paint Palette		Ultra Metallic Paint		Special Effect Paint	
		Gloss	Satin	Gloss	Satin
		\$ 4,550	\$ 7,450	\$ 9,200	\$ 12,050
	Sunset Gold	1FL	1FM	NA	NA
	Tourmaline Brown	1FR	1FS	NA	NA
	Constellation Blue	1FB	NA	NA	NA
	Icy White	NA	NA	1FG	1FH
	Ionian Silver	1FJ	1FK	NA	NA
	Ethereal Frost Silver	1EY	1FD	NA	NA
	Flux Silver	1EW	1EX	NA	NA
	Amethyst Grey-Purple	1FN	NA	NA	NA
	Ligurian Black	1ET	1EU	NA	NA
	Petrolix Blue	1FP	NA	NA	NA
	British Racing Green	1ES	1EV	NA	NA
	Velocity Blue	1EZ	1FC	NA	NA
	Sanguinello Orange	1FT	NA	NA	NA
	Sunrise Copper	1GA	1GB	NA	NA

Changes in standard equipment, options or prices can occur. Land Rover reserves the right to change product specifications at any time without incurring any obligations.

8. WHEELS AND TIRES

Wheel	Option Code	SE i6	SE PHEV	SE V8	ATB	First Edition	SV
 21" Style 5112	031VU	S	S	NA		NA	
 21" Style 7021, Diamond Turned with Gloss Dark Grey contrast	031VW	NA	NA	S	NCO	NA	NA
 22" Style 7023	031ZE	\$1,500	\$1,500	\$1,500	NA		NA
 22" Style 7023 Diamond Turned with Black Contrast	039KC	\$2,300	\$2,300	\$1,500	\$350	NA	NCO
 22" Style 7023 Diamond Turned with Dark Grey Contrast	031ZR	NA					S
 SV Bespoke 22" Style 1072, Diamond Turned with Black contrast	031VX	\$2,800	\$2,800	\$2,000	\$900	NCO	NCO
 22" Style 1073, Diamond Turned with Gloss Dark Grey contrast	031WA	\$2,300	\$2,300	\$1,500	S	NA	NCO
 22" Style 1073 Gloss Black	032AJ	\$2,100	\$2,100	\$2,100	\$600	NA	NA











Changes in standard equipment, options or prices can occur. Land Rover reserves the right to change product specifications at any time without incurring any obligations.

Wheel	Option Code	SE i6	SE PHEV	SE V8	ATB	First Edition	SV	
 23" Style 1074	032AH	NA	NA	NA	NA	S	NA	
 23" Style 1075 Gloss Black	032AG	\$3,600	NA	\$3,000	\$1,500	\$900	NA	
 23" Style 1075, Diamond Turned with Gloss Dark Grey contrast	031WB	\$3,800	NA	\$3,000	\$1,500	NA	NA	
 SV Bespoke 23" Style 1079, Silver with Gloss Dark Grey contrast	031ZF	\$4,300	NA	\$3,500	\$2,000	NA	NA	
 23" forged, Style 1077, Satin Dark Grey with Satin Black contrast and Narvik Black Gloss inserts	031ZT	NA						\$3,700
 23" Style 1077 Diamond Turned with Gloss Dark Grey contrast and Corinthian Bronze Satin inserts	031XH	NA						\$3,700
 23" forged Style 1077 Diamond Turned with Gloss Dark Grey contrast and Bright Atlas Satin inserts	031ZS	NA						\$3,700
21" full size spare	028MD	\$450	\$450	\$450	\$450	NA	NA	
22" full size spare	028ME	\$500	\$500	\$500	\$500	\$500	\$500	
23" full size spare	028MF	\$550	NA	\$550	\$550	\$550	\$550	

S = Standard O = Optional N/A = Not available NCO = No Cost Option

Changes in standard equipment, options or prices can occur. Land Rover reserves the right to change product specifications at any time without incurring any obligations.

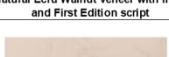
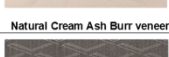
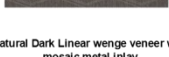
9. TRIM FINISHERS AND VENEERS

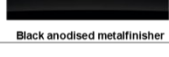
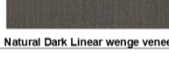
Trim	Option Code	SE	ATB	First Edition	SV	Rules
 Natural Brown Silver Birch veneer	088TS	\$650	NCO	NA	NA	N/A on Perlino/Ebony, Ecu, Deep Garnet or Ebony/Ebony Only available on Caraway Interior with Wood & Leather steering wheel
 Natural Brown Walnut	088TU	S	NCO	NA	NA	N/A on Perlino and Ecu Interior with Wood & Leather steering wheel.
 Natural Ecu Walnut	088TV	\$650	NCO	NA	NA	N/A on Caraway and Ebony. N/A on Caraway, Ebony, Deep Garnett with Wood & Leather steering wheel.
 Natural Black Birch veneer	088UX	\$1,300	\$1,300	NA	NCO	N/A with Ecu Interior with Wood & Leather steering wheel Only available with Intrepid Interiors on SV
 Gloss Grand Black	088EH	\$1,300	NCO	NA	NA	No Restrictions
 SV Bespoke Natural Brown Walnut veneer with Inlay	088TW	NA	S	NA	NA	N/A on Perlino and Ecu Interior with Wood & Leather steering wheel.
 SV Bespoke Natural Ecu Walnut veneer with Inlay	088TX	NA	NCO	NA	NA	N/A on Caraway and Ebony.
 Natural Black Birch veneer with inlay and First Edition script	088UV	NA		NCO	NA	Only available with Ebony interior
 Natural Ecu Walnut veneer with inlay and First Edition script	088UE	NA		S	NA	Only available with Perlino interior
 Natural Cream Ash Burr veneer	088UN				S	Only available with Ebony, Ebony/Perlino and Serenity Interiors
 Natural Dark Linear wenge veneer with mosaic metal inlay	088UP				\$1,350	Only available with Ebony, Ebony/Perlino and Serenity Interiors
 Natural Light Linear wenge veneer with mosaic marquetry	088UQ				\$1,350	Only available with Ebony, Ebony/Perlino and Serenity Interiors
 Black anodised metal finisher	088UR		NA		\$1,350	Only available with Intrepid Interiors N/A with SV Bespoke wood and leather steering wheel.
 Natural Dark Linear wenge veneer	088UZ				NCO	Only available with Ebony, Ebony/Perlino and Serenity Interiors
 Satin Dark woven mesh finisher	088WA				\$1,350	Only available with Intrepid Interiors N/A with SV Bespoke wood and leather steering wheel.
 Satin White ceramic finisher with embossed mosaic	088UG				\$2,640	Only available with Ebony, Ebony/Perlino and Serenity Interiors

10. PRICING APPENDIX

*Satin Dark Woven Meshfinisher available from Mid 2022 on

Derivative	Engine	Model Code	Derivative Code	Dealer Invoice	Suggested Retail Price
SE SWB	395hp 3.0i i6 Turbocharged Gas Engine	AC460/460AU	5000827279	\$94,940	\$101,000
SE SWB	434hp 3.0i i6 Plug-in Hybrid Engine	AG460/460CQ	5000827293	\$98,606	\$104,900
SE LWB 7	395hp 3.0i i6 Turbocharged Gas Engine	AJ460/460CB	5000827289	\$100,580	\$107,000
SE SWB	523hp 4.4L V8 TurboCharged Gas Engine	AS460/460AZ	5000827277	\$111,578	\$118,700
Autobiography SWB	523hp 4.4L V8 TurboCharged Gas Engine	AS460/460BB	5000827275	\$143,303	\$152,450
First Edition SWB	523hp 4.4L V8 TurboCharged Gas Engine	AS460/460BC	5000827276	\$149,131	\$158,650
Autobiography LWB 5	523hp 4.4L V8 TurboCharged Gas Engine	AW460/460BB	5000827282	\$147,063	\$156,450
First Edition LWB 5	523hp 4.4L V8 TurboCharged Gas Engine	AW460/460BC	5000827283	\$154,113	\$163,950
SE LWB 7	523hp 4.4L V8 TurboCharged Gas Engine	AW460/460CF	5000827286	\$117,218	\$124,700
Autobiography LWB 7	523hp 4.4L V8 TurboCharged Gas Engine	AW460/460CH	5000827285	\$145,183	\$154,450
SV SWB	523hp 4.4L V8 TurboCharged Gas Engine	AS460/460DB	5000827278	\$175,639	\$186,850
SV LWB	523hp 4.4L V8 TurboCharged Gas Engine	AW460/460DB	5000827287	\$198,528	\$211,200

Exterior						
Shadow Exterior Pack	All excluding SV	Exterior	032XX	\$940	\$1,000	
Nickel Atlas Exterior Pack	ATB	Exterior	032MT	-	NCO	
Black contrast roof	All	Exterior	080AN	\$940	\$1,000	
Black brake calipers	SE	Exterior	020BK	\$517	\$550	
Heated windscreen	All	Exterior	040AK	\$329	\$350	
Tow hitch receiver	All	Exterior	028LB	\$705	\$750	
Self-sealing tyres	All	Exterior	030JC	\$188	\$200	
Pixel LED headlights with signature DRL	SE	Exterior	064QW	\$517	\$550	
Red brake calipers	SV	Exterior	020BE	\$479	\$510	
Corinthian Bronze contrast roof	SV SWB	Exterior	080IK	\$1,410	\$1,500	
	SV LWB	Exterior	080IK	-	NCO	
SV Serenity exterior accents	SV SWB	Exterior	032MZ	\$1,692	\$1,800	
	SV LWB	Exterior	032MZ	-	NCO	
SV Intrepid exterior accents	SV	Exterior	032PX	\$1,692	\$1,800	
Versatility & Capability	Model Derivative	Vista Category	Option Code	Dealer Invoice	Suggested Retail Price	
Technology Pack	SE	Technology	074KY	\$1,880	\$2,000	
Advanced Off-Road Capability Pack	SE i6	Technology	074PM	\$4,935	\$5,250	
Meridian™ 3D Surround Sound System	SE	Technology	025MN	\$1,128	\$1,200	
11.4" Rear Seat Entertainment	SE	Technology	129AW	\$2,961	\$3,150	
No Rear Seat Entertainment	SV, ATB and First Edition	Technology	129XX	-	NCO	
Configurable Programs	SE V8	Technology	184AD	\$517	\$550	
Cabin Air Purification Pro	SE V8	Technology	022GJ	\$470	\$500	
Advanced Tow Assist	All	Technology	062CE	\$423	\$450	
Park Assist	SE	Technology	086MC	\$188	\$200	
Power Assisted Doors	All excluding SV	Technology	173AD	\$1,645	\$1,750	
Soft Close Doors	SV	Technology	173AB	-	NCO	
Paint Options	Model Derivative	Vista Category	Option Codes	Dealer Invoice	Suggested Retail Price	
Solid Paint (1AA)	SE, ATB	Paint	1AA	-	NCO	
Metallic Paint (1AG, 1DF, 1DG, 1DP, 1DU, 1DV, 1EJ)	SE, ATB, SV	Paint	Multiple	-	NCO	
Metallic Paint (1CN, 1EH)	SV	Paint	Multiple	-	NCO	
Metallic & Premium Metallic Paint (1AG, 1DP, 1DM, 1DN)	First Edition	Paint	Multiple	-	NCO	
Premium Metallic Paint (1AU, 1BN, 1DM, 1DN)	SE, ATB, SV	Paint	Multiple	\$1,833	\$1,950	
SV Bespoke Ultra Metallic Gloss (1ES, 1ET, 1EW, 1EY, 1EZ, 1FB, 1FJ, 1FL, 1FN, 1FP, 1FR, 1FT)	SE, ATB, SV	Paint	Multiple	\$4,277	\$4,550	
SV Bespoke Metallic Satin (1EU, 1EV, 1EX, 1FC, 1FD, 1FK, 1FS)	SE, ATB, SV	Paint	Multiple	\$7,003	\$7,450	
SV Bespoke Metallic Satin	First Edition, SV	Paint	1FM	\$7,003	\$7,450	
SV Bespoke Special Effect Gloss	SE, ATB, SV	Paint	1FG	\$8,648	\$9,200	
SV Bespoke Special Effect Satin	SE, ATB, SV	Paint	1FH	\$11,327	\$12,050	
SV Bespoke Special Effect Gloss	SV	Paint	1GA	\$4,277	\$4,550	
SV Bespoke Special Effect Satin	SV	Paint	1GB	\$7,003	\$7,450	

Interior, Trim & Veneer Options	Model Derivative	Vista Category	Option Codes	Dealer Invoice	Suggested Retail Price
20-way heated and ventilated electric front seats with power recline heated and ventilated rear seats	SE SWB	Interior	401AJ	\$564	\$600
20-way heated and ventilated electric front seats with power recline heated and ventilated rear seats and heated third row seats	SE LWB	Interior	401AK	\$564	\$600
24-way heated and cooled, massage electric front seats with power recline heated and ventilated rear seats	SE SWB	Interior	401AM	\$1,880	\$2,000
24-way heated and cooled, massage electric front seats with power recline heated and ventilated rear seats	ATB (excl 7 seat) and First Edition	Interior	401AM	-	NCO
24-way heated and cooled, massage electric front seats with power recline heated and ventilated rear seats and heated third row seats	SE LWB	Interior	401AN	\$1,504	\$1,600
24-way heated and cooled, massage electric front seats with Executive Class rear seats	SE SWB	Interior	401AP	\$3,948	\$4,200
	ATB (excl 7 seat) and First Edition	Interior	401AP	-	NCO
24-way heated and cooled, hot stone massage electric front seats with Executive Class Comfort Plus rear seats	ATB SWB	Interior	401AR	\$3,572	\$3,800
24-way heated and cooled, hot stone massage electric front seats with Executive Class Comfort Plus rear seats	ATB LWB	Interior	401AS	\$4,888	\$5,200
Caraway perforated Windsor leather seats with Caraway interior	SE	Interior	301MY	-	NCO
Perlino perforated Windsor leather seats with Perlino interior	SE	Interior	301MZ	-	NCO
Ecru perforated Windsor leather seats with Ecru interior	SE SWB	Interior	301RA	-	NCO
Ebony perforated Semi-Aniline leather seats with Ebony interior	SE	Interior	301RB	\$1,739	\$1,850
	First Edition	Interior	301RB	-	NCO
Caraway perforated Semi-Aniline leather seats with Caraway	SE	Interior	301RC	\$1,739	\$1,850
	ATB	Interior	301RC	-	NCO
Perlino perforated Semi-Aniline leather seats with Perlino interior	SE	Interior	301RD	\$1,739	\$1,850
	ATB	Interior	301RD	-	NCO
Deep Garnet perforated Semi-Aniline leather seats with Deep Garnet	SE SWB	Interior	301RF	\$1,739	\$1,850
	ATB	Interior	301RF	-	NCO
SV Bespoke Ebony perforated Near-Aniline leather seats with Ebony	ATB (excl 7 seat)	Interior	301TG	\$1,081	\$1,150
Ebony perforated Ultrafabrics™ and Kvadrat™ premium wool blend textile seats with Ebony interior	All Excluding 7 Seat & SV	Interior	301RM	-	NCO
Ebony perforated Windsor leather seats with Perlino interior	SE	Interior	301TJ	-	NCO
Ebony perforated Semi-Aniline leather seats with Perlino interior	SE	Interior	301TM	\$1,739	\$1,850
Ebony perforated Semi-Aniline leather seats with Perlino interior	ATB	Interior	301TM	-	NCO
SV Bespoke Ebony perforated Near-Aniline leather seats with Perlino interior	ATB (excludes 7 Seat)	Interior	301TS	\$1,081	\$1,150
Premium Non-leather Upgrade	All Excluding 7 Seat	Interior	032KF	-	NCO
Perlino headlining	SE	Interior	188MA	\$376	\$400
	ATB	Interior	188MA	-	NCO
Ebony Morzine headlining	SE	Interior	188HD	\$376	\$400
	ATB	Interior	188HD	-	NCO
Duo Tone Ebony/Perlino headlining	ATB and First Edition	Interior	188HW	-	NCO
Duo Tone Ebony/Caraway headlining	SE	Interior	188HV	-	NCO
Duo Tone Ebony/Ecru headlining	SE SWB	Interior	188HX	-	NCO
Duo Tone Ebony/Deep Garnet headlining	SE SWB	Interior	188HZ	-	NCO
SV Bespoke Ebony leather headlining	ATB	Interior	188HQ	-	NCO
SV Bespoke Perlino Leather Headlining	ATB, SV	Interior	188MM	-	NCO
SV Bespoke Duo Tone Ebony/Caraway Leather Headlining	ATB	Interior	188MG	-	NCO
SV Bespoke Duo Tone Ebony/Deep Garnet Leather Headlining	ATB (excludes 7 Seat)	Interior	188ML	-	NCO
Premium Upgrade Interior Pack	SE SWB	Interior	017HE	\$1,880	\$2,000
	SE LWB	Interior	017HE	\$1,739	\$1,850
Loadspace partition net	ATB, SV	Interior	026EU	\$94	\$100
Tailgate Event Suite	SE (exc. 7 Seat)	Interior	079EK	\$1,175	\$1,250
	ATB SWB, SV	Interior	079EK	\$470	\$500
	First Edition, ATB LWB (Excl 7 Seat)	Interior	079EK	-	NCO
Tailgate Event Suite with Leather Cushions	SE	Interior	079EL	\$1,833	\$1,950
	ATB, SV	Interior	079EL	\$1,128	\$1,200
Front center console refrigerator compartment	SE LWB	Interior	045CB	\$705	\$750
Illuminated seat belt buckles	SE	Interior	032QB	-	NCO
Heated steering wheel	SE	Interior	032DV	\$282	\$300
Premium non-leather steering wheel	All Excluding 7 Seat	Interior	032LZ	-	NCO
SV Bespoke Wood and leather steering wheel (Gloss)	All except SV	Interior	032NR	\$517	\$550
SV Bespoke Wood and leather steering wheel (Open Pore)	All	Interior	032NT	\$517	\$550
Hot Climate Pack	SE SWB	Interior	017ED	\$2,068	\$2,200

Changes in standard equipment, options or prices can occur. Land Rover reserves the right to change product specifications at any time without incurring any obligations.

Interior, Trim & Veneer Options	Model Derivative	Vista Category	Option Codes	Dealer Invoice	Suggested Retail Price
Natural Brown Silver Birch	SE	Interior	088TS	\$611	\$650
Natural Brown Walnut	ATB	Interior	088TS	-	NCO
Natural Ecru Walnut	ATB	Interior	088TU	-	NCO
	SE	Interior	088TV	\$611	\$650
	ATB	Interior	088TV	-	NCO
Grand Black	SE	Interior	088EH	\$1,222	\$1,300
	ATB	Interior	088EH	-	NCO
Natural Ecru Walnut with Inlay	ATB	Interior	088TX	-	NCO
Black Silver Birch First Ed	First Edition	Interior	088UV	-	NCO
Natural Black Birch	SE, ATB	Interior	088UX	\$1,222	\$1,300
	SV	Interior	088UX	-	NCO
Caraway carpet	SV	Interior	124BC	-	NCO
Mohair mats with leather binding	SV SWB	Interior	079DP	\$1,269	\$1,350
Pearl Oyster Carpet	SV	Interior	124BE	\$1,833	\$1,950
Sequoia Green Carpet	SV	Interior	124BF	-	NCO
Liberty Blue Carpet	SV	Interior	124BG	-	NCO
Cinder Grey Carpet	SV	Interior	124BH	-	NCO
SV Deep Pile carpet mats	SV	Interior	079DV	\$1,269	\$1,350
Satin Black ceramic controls	SV	Interior	305BD	-	NCO
Satin White ceramic finisher with embossed mosaic	SV	Interior	088UG	\$2,482	\$2,640
Natural Dark Linear wenge veneer with mosaic metal inlay	SV	Interior	088UP	\$1,269	\$1,350
Natural Light Linear wenge veneer with mosaic marquetry	SV	Interior	088UQ	\$1,269	\$1,350
Black anodised metal finisher	SV	Interior	088UR	\$1,269	\$1,350
Natural Dark Linear wenge veneer	SV	Interior	088UZ	-	NCO
Satin Dark woven mesh finisher	SV	Interior	088WA	\$1,269	\$1,350
SV Serenity Caraway Near-Aniline leather front and Perlino Semi-Aniline rear	SV	Interior	303UJ	\$3,102	\$3,300
SV Serenity Liberty Blue Near-Aniline leather front and Perlino Semi-Aniline rear	SV	Interior	303UK	\$3,102	\$3,300
SV Serenity Sequoia Green Near-Aniline leather front and Perlino Semi-Aniline rear	SV	Interior	303UM	\$3,102	\$3,300
SV Intrepid Light Cloud front and Cinder Grey rear Ultrafabric seats with leather headlining	SV	Interior	303UN	\$3,102	\$3,300
SV Intrepid Rosewood Near-Aniline leather front and Ebony Semi-Aniline rear	SV	Interior	303UP	\$3,102	\$3,300
SV Intrepid Ebony Semi-Aniline leather seats with Ebony interior	SV	Interior	303UQ	\$3,102	\$3,300
SV Perlino Semi-Aniline leather seats with Perlino interior	SV	Interior	303UR	-	NCO
Caraway leather headlining	SV	Interior	188MR	-	NCO
Liberty Blue leather headlining	SV	Interior	188MS	-	NCO
Sequoia Green leather headlining	SV	Interior	188MT	-	NCO
Cinder Grey Ultrafabrics headlining	SV	Interior	188MV	-	NCO
SV Signature Suite with Leather Club Table Surface	SV LWB	Interior	017HN	\$18,556	\$19,740
SV Signature Suite with Veneer Club Table Surface	SV LWB	Interior	017HP	\$18,556	\$19,740
Wheel Options	Model Derivative	Vista Category	Option Codes	Dealer Invoice	Suggested Retail Price
21" Style 7021, Diamond Turned with Gloss Dark Grey contrast	ATB Derivatives	Wheels	031VW	-	NCO
22" Style 7023	SE Derivatives	Wheels	031ZE	\$1,410	\$1,500
	SE i6	Wheels	031VX	\$2,632	\$2,800
	SE V8	Wheels	031VX	\$1,880	\$2,000
SV Bespoke 22" Style 1072, Diamond Turned with Satin Black contrast	ATB	Wheels	031VX	\$846	\$900
	First Edition	Wheels	031VX	-	NCO
	SE i6	Wheels	039KC	\$2,162	\$2,300
SV Bespoke 22" Style 1072, Diamond Turned with Satin Black contrast	SE V8	Wheels	039KC	\$1,410	\$1,500
	ATB	Wheels	039KC	\$329	\$350
	SE i6	Wheels	031WA	\$2,162	\$2,300
22" Style 1073, Diamond Turned with Gloss Dark Grey contrast	SE V8	Wheels	031WA	\$1,410	\$1,500
	SE	Wheels	032AJ	\$1,974	\$2,100
22" Style 1073 Gloss Black	ATB	Wheels	032AJ	\$564	\$600
	SE i6 (excl PHEV)	Wheels	032AG	\$3,384	\$3,600
	SE V8	Wheels	032AG	\$2,820	\$3,000
	ATB	Wheels	032AG	\$1,410	\$1,500
	First Edition	Wheels	032AG	\$846	\$900
	SE i6 (excl PHEV)	Wheels	031WB	\$3,572	\$3,800
	SE V8	Wheels	031WB	\$2,820	\$3,000
23" Style 1075 Gloss Black	ATB	Wheels	031WB	\$1,410	\$1,500
	SE i6 (excl PHEV)	Wheels	031ZF	\$4,042	\$4,300
	SE V8	Wheels	031ZF	\$3,290	\$3,500
SV Bespoke 23" Style 1079, Silver with Gloss Dark Grey contrast	ATB	Wheels	031ZF	\$1,880	\$2,000
23" forged, Style 1077, Satin Dark Grey with Satin Black contrast and N	SV	Wheels	031ZT	\$3,478	\$3,700
23" Style 1077 Diamond Turned with Gloss Dark Grey contrast and Co	SV	Wheels	031XH	\$3,478	\$3,700
23" forged Style 1077 Diamond Turned with Gloss Dark Grey contrast a	SV	Wheels	031ZS	\$3,478	\$3,700
21" Full size spare wheel	All except 7 Seat LWB and First Edition	Wheels	028MD	\$423	\$450
22" Full size spare wheel	All except 7 Seat LWB	Wheels	028ME	\$470	\$500
23" Full size spare wheel	All except 7 Seat LWB & SE PHEV	Wheels	028MF	\$517	\$550
Accessories	Model Derivative	Vista Category	Option Codes	Dealer Invoice	Suggested Retail Price
Emergency Pack	All	Other	LRX95	\$59	\$65
Premium Interior Protection & Storage Pack	SWB	Other	RR001	\$585	\$650
Premium Interior Protection & Storage Pack	LWB, 5-Seat	Other	RR011	\$585	\$650
Premium Interior Protection & Storage Pack	SE, ATB	Other	RR071	\$585	\$650
Wheel Protection Pack	All	Other	RR003	\$171	\$190
Fixed Side Steps, Black Optic	SWB	Other	RR005	\$1,376	\$1,600
Deployable Side Steps	SWB	Other	RR009	\$3,612	\$4,200
Deployable Side Steps	LWB	Other	RR0L9	\$3,956	\$4,600
Deployable Side Steps	LWB, 7-Seat	Other	RR079	\$3,956	\$4,600

Changes in standard equipment, options or prices can occur. Land Rover reserves the right to change product specifications at any time without incurring any obligations.